

Light Units for Line Sensor LNSP2 Series

**Achieved an Illuminance of 900,000 lx*
using a natural air-cooling system.**

* When LNSP2-300SW-NDF is used at the LWD of 50 mm.



Applications

- Visual inspection for non-woven fabrics
- Visual inspection for glass
- Visual inspection for films
- Visual inspection for electronic components and board

High Illuminance Light Units for Line Sensor

LNSP2 Series

Natural
air-cooling

Fan-less design
Easy installation

Approx. **900,000 lx**

NDF type
LNSP2-300SW-NDF

Approx. **650,000 lx**

Standard type
LNSP2-300SW

LWD=50mm

NDF type
(The diffusion sheet
is omitted.)

Brand New!

- Improves production cycle time
- Enhances detection capability
- Can be used together with lenses with high f-number



Weight
1,000g
For LNSP2-300SW

42 mm
70 mm

LNSP2 Series

Typical size of the Light Units with an output illuminance of one million lx or more

(Conceptual image)

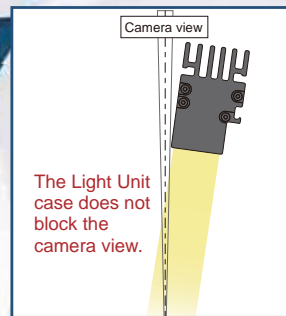

The Light Unit case does not block the camera view.

Workpiece: Paper

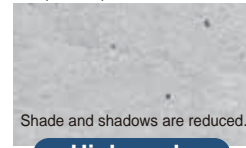

Shade and shadows are reduced.

High angle

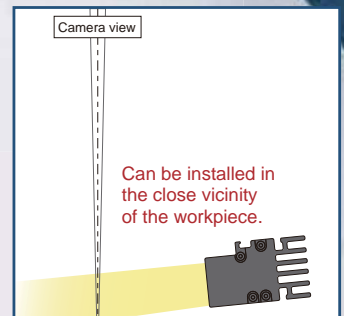

Can be installed in the close vicinity of the workpiece.

Workpiece: Paper

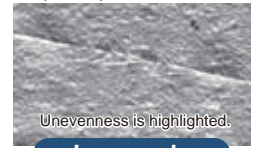

Unevenness is highlighted.

Low angle

Light-weight and compact body

**Well-designed Light Unit shape:
Great for use at the site of inspection**

Comparing performance with other CCS Line Lights

Characteristics Chart



Change in Illuminance

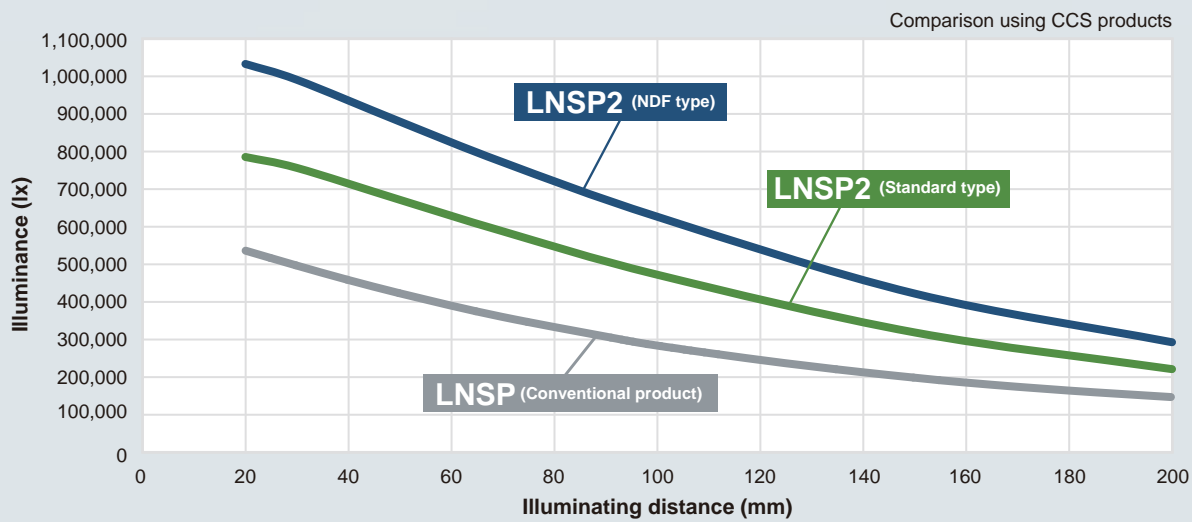

Note: Actual measurement values at the center of the emitting surface, 100% intensity. Results for individual products may vary.

Comparing Uniformity

	▼ LNSP2 (NDF type)	▼ LNSP2 (Standard type)	▼ LNSP (Conventional product)
Emitting surface			
Irradiance distribution	<p>Note: Actual measurement values at 100% intensity in 100 mm illuminating distance. Results for individual products may vary.</p>	<p>Note: Actual measurement values at 100% intensity in 100 mm illuminating distance. Results for individual products may vary.</p>	<p>Note: Actual measurement values at 100% intensity in 100 mm illuminating distance. Results for individual products may vary.</p>
Radiance distribution			

Note: The graphs included are for reference only. Actual values may vary.

Differences between the Standard and NDF-type Light Units

■ LNSP2 (Standard type)



A diffusion sheet is included.

Can be used for a wide range of applications.

■ LNSP2 (NDF type)



Diffusion sheet is not included.

Good for a dark field inspection.

Different imaging results of the typical workpieces

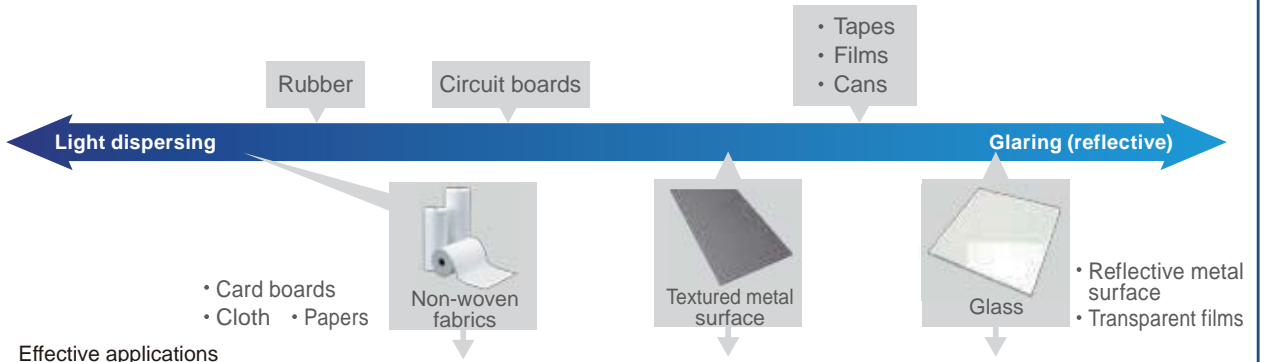

Effective applications

LNSP2 (Standard type)

	Bright field			
	Dark field			

* See the note below.

LNSP2 (NDF type)

	Bright field			
	Dark field			

* See the note below.

* The vertical lines in the images with an asterisk mark (*) were caused by reflections of light from LEDs.

Imaging Examples

Imaging stains on non-woven fabrics



Comparison of images between different irradiating angles

Captured image 1



Possible to take an image that emphasizes the unevenness of the surface material.

Fault inspection with a low-angle irradiation

Light Unit in use: LNSP2-300SW

Captured image 2



Possible to take an image that cancels the unevenness of the surface material.

Fault inspection with a high-angle irradiation

Light Unit in use: LNSP2-300SW

Imaging the external appearance of circuit boards

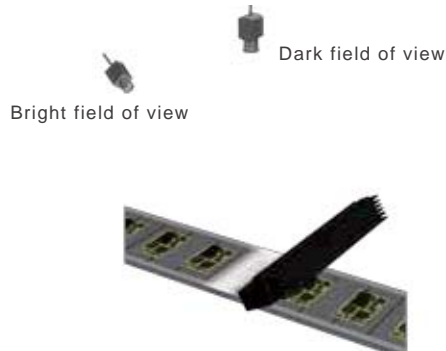

Comparison of images between bright and dark field of views

Captured image 1

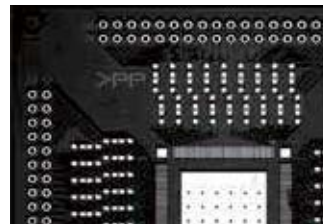

Bright field of view

Detecting only the plating parts on the board.

Light Unit in use: LNSP2-300SW

Captured image 2



Dark field of view

Detecting only the characters on the board.

Light Unit in use: LNSP2-300SW

Imaging stains and scratches on glass

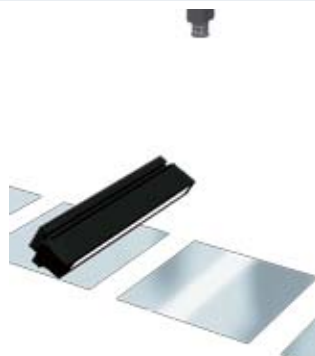

Imaging examples of different defects when the same irradiation method is used

Captured image 1

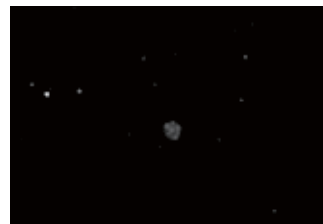

Dark field of view

Detecting stains on the glass.

Light Unit in use: LNSP2-300SW

Captured image 2

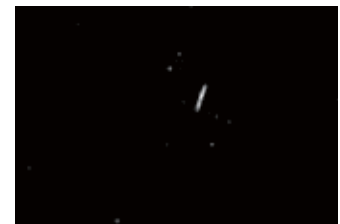

Dark field of view

Detecting scratches on the glass.

Light Unit in use: LNSP2-300SW

Imaging the external appearance of electronic components



Comparison of brightness between the LNSP2 (standard type) and the LNSP (conventional product)

LNSP2 (Standard type)

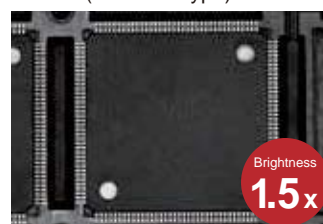

When the CU-LNSP2 Coaxial Unit is used.

LNSP (Conventional product)

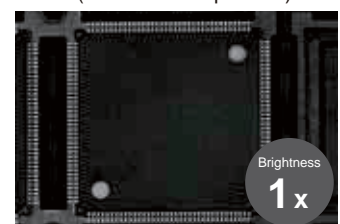

When the CU-LNSP Coaxial Unit is used.

Detecting the plating parts on the board.

Light Unit in use: LNSP2-300SW

Light Unit in use: LNSP-300SW

Data

LNSP2 (Standard type)



Note: The data included are actual measurement values when LNSP2-300SW is used. Results for individual products may vary.

Relative irradiance distribution

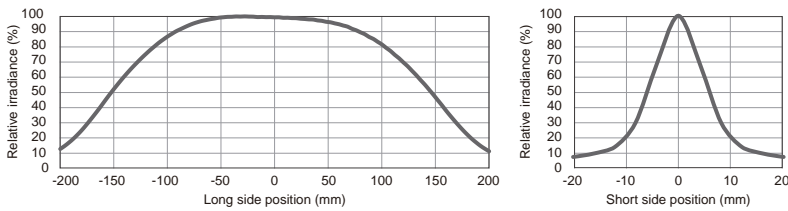

Change in illuminance^{*1}

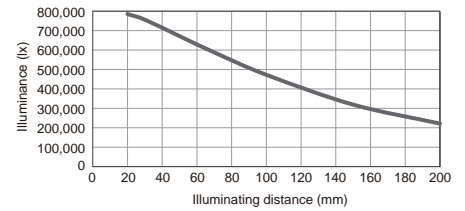

Relative radiance distribution

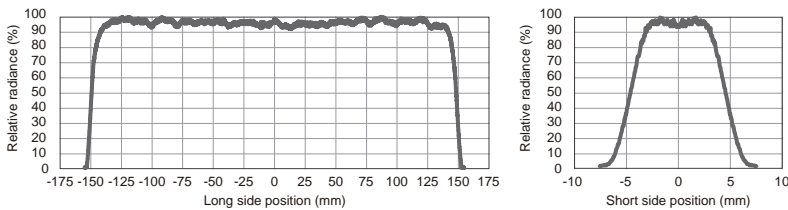

Light output characteristics^{*2, 3}

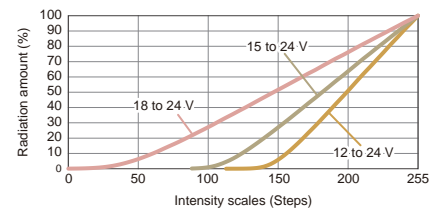

Illumination distribution characteristics

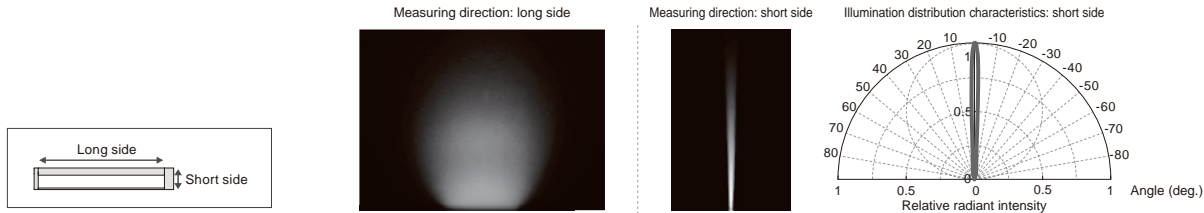

LNSP2 (NDF type)



Note: The data included are actual measurement values when LNSP2-300SW-NDF is used. Results for individual products may vary.

Relative irradiance distribution

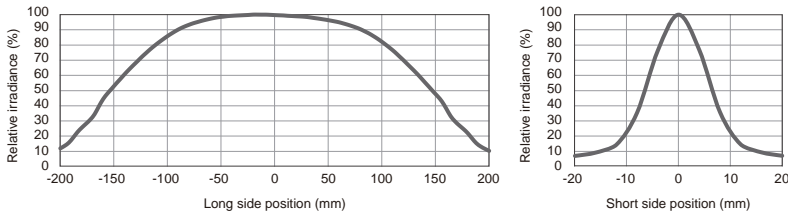

Change in illuminance^{*1}

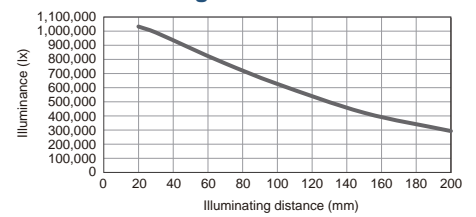

Relative radiance distribution

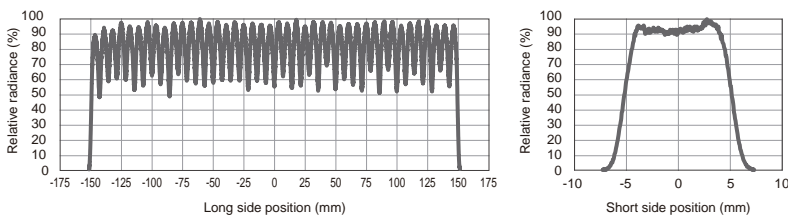

Light output characteristics^{*2, 3}

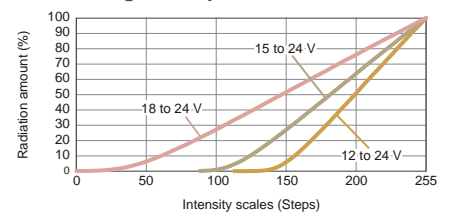

Illumination distribution characteristics

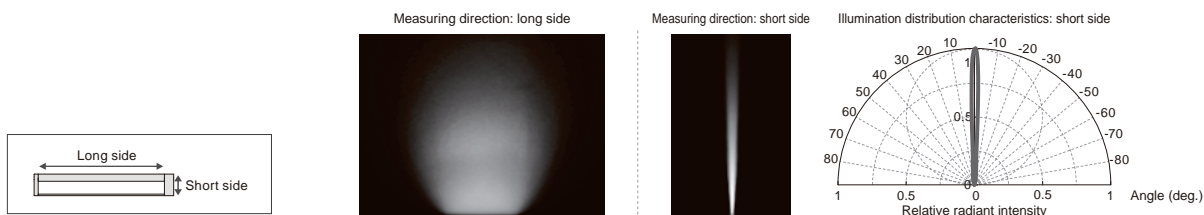

*1 Actual measurement values at 100% intensity in each illuminating distance. Results for individual products may vary.
*2 Actual measurement values when the Analog Control Unit PSB3-30024 is used. Results for individual products may vary.

*3 Measured in each voltage range because the Analog Control Unit PSB3-30024 has a switching function for the lower limit of output voltage. Note: The graph included is for reference only. Actual values may vary.

LNSP2 Series

Specifications

LED color	White (SW)
Correlated color temperature	6,600 K (typ.)
Input voltage	24 VDC max.
Case material	Aluminum alloy, Resin
Cable length	300 mm
Operating environment	0 to 40°C, Humidity: 20 to 85%RH (with no condensation)
Storage environment	-20 to 60°C, Humidity: 20 to 85%RH (with no condensation)
CE marking	Safety standard: Conforms to EN62471
Environmental regulations	RoHS compliant

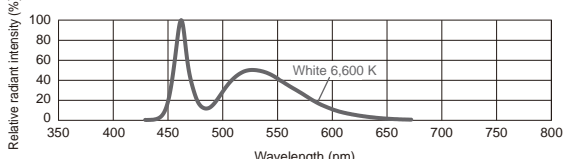
Cooling method	Natural air-cooling
Accessories	Instruction guide
Spectral distribution	

Note: The data included is for reference only. Actual values may vary.

Product Lineup

Standard type (The diffusion sheet is included.)

Model name	Emitting surface length	Power consumption (max.)	Extension cable	Recommended Control Unit	Weight (max.)
LNSP2-100SW	100 mm	20 W	FCB-EL2 (EL connector)	Analog Control Unit PSB3-30024	400 g
LNSP2-200SW	200 mm	40 W		700 g	
LNSP2-300SW	300 mm	60 W		1,000 g	
LNSP2-400SW	400 mm	80 W		Digital Control Unit PD3-10024-8	1,300 g
LNSP2-500SW	500 mm	100 W		1,600 g	
LNSP2-600SW	600 mm	120 W	FCB-ME7 (Metal connector)	Analog Control Unit PSB3-30024	1,900 g
LNSP2-700SW	700 mm	140 W			2,200 g
LNSP2-800SW	800 mm	160 W			2,500 g
LNSP2-900SW	900 mm	180 W			2,800 g
LNSP2-1000SW	1,000 mm	200 W			3,100 g

NDF type (The diffusion sheet is not included.)

Model name	Emitting surface length	Power consumption (max.)	Extension cable	Recommended Control Unit	Weight (max.)
LNSP2-100SW-NDF	100 mm	24 W	FCB-EL2 (EL connector)	Analog Control Unit PSB3-30024	400 g
LNSP2-200SW-NDF	200 mm	48 W		700 g	
LNSP2-300SW-NDF	300 mm	72 W		Digital Control Unit PD3-10024-8	1,000 g
LNSP2-400SW-NDF	400 mm	96 W		1,300 g	
LNSP2-500SW-NDF	500 mm	120 W		1,600 g	
LNSP2-600SW-NDF	600 mm	144 W	FCB-ME7 (Metal connector)	Analog Control Unit PSB3-30024	1,900 g
LNSP2-700SW-NDF	700 mm	168 W			2,200 g
LNSP2-800SW-NDF	800 mm	192 W			2,500 g
LNSP2-900SW-NDF	900 mm	216 W			2,800 g
LNSP2-1000SW-NDF	1,000 mm	240 W			3,100 g

Note: CCS accepts custom orders for such as LED colors other than white, sizes, and the position where the light cable comes out of the case. Please contact your CCS sales representative for details.

For detailed information on the Control Units, refer to CCS website or *General Catalog of LED Lighting for Machine Vision Applications*.

Analog Control Unit PSB3-30024



Digital Control Unit PD3-10024-8

Note: Custom products with a PWM frequency of 500 kHz are available for the Digital Control Unit PD3 series. Please contact your CCS sales representative for details.

Dimensions (mm)

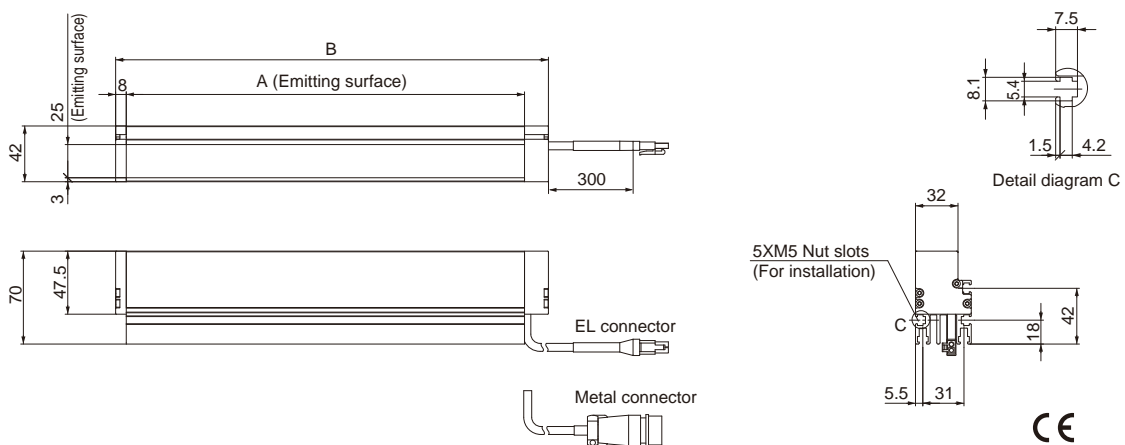

Model name	A: Emitting surface (mm)	B: Total length (mm)	Connector
LNSP2-100SW(-NDF)	100	126	EL connector
LNSP2-200SW(-NDF)	200	226	
LNSP2-300SW(-NDF)	300	326	
LNSP2-400SW(-NDF)	400	426	
LNSP2-500SW(-NDF)	500	526	

Model name	A: Emitting surface (mm)	B: Total length (mm)	Connector
LNSP2-600SW(-NDF)	600	626	Metal connector
LNSP2-700SW(-NDF)	700	726	
LNSP2-800SW(-NDF)	800	826	
LNSP2-900SW(-NDF)	900	926	
LNSP2-1000SW(-NDF)	1,000	1,026	

Optional Accessories

Extension cables | These extension cables are used to connect the Light Unit and Control Unit.

FCB-EL2

Model name	Cable length (m)	Weight (g)
FCB-1-EL2	1	85
FCB-2-EL2	2	165
FCB-3-EL2	3	245
FCB-5-EL2	5	405
FCB-10-EL2	10	805
FCB-15-EL2	15	1,205

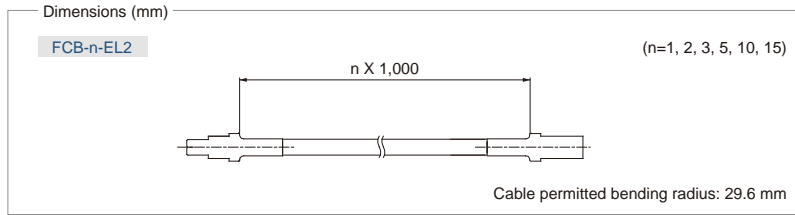

FCB-ME7

Model name	Cable length (m)	Weight (g)
FCB-2-1.25SQ-ME7	2	430
FCB-3-1.25SQ-ME7	3	580
FCB-5-1.25SQ-ME7	5	1,000
FCB-10-1.25SQ-ME7	10	2,000
FCB-20-2.0SQ-ME7	20	5,000

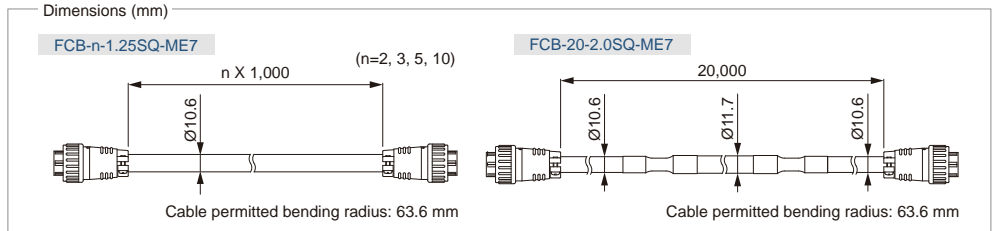

Coaxial Units



CU-LNSP2 Series

Coaxial light from the same axis as a camera lens enables imaging without shadow.

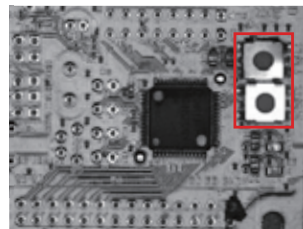

There is no shadow in the space between electronic parts, allowing for visual inspection.

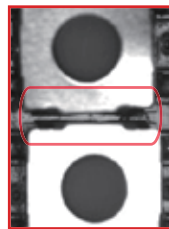

Enlarged image

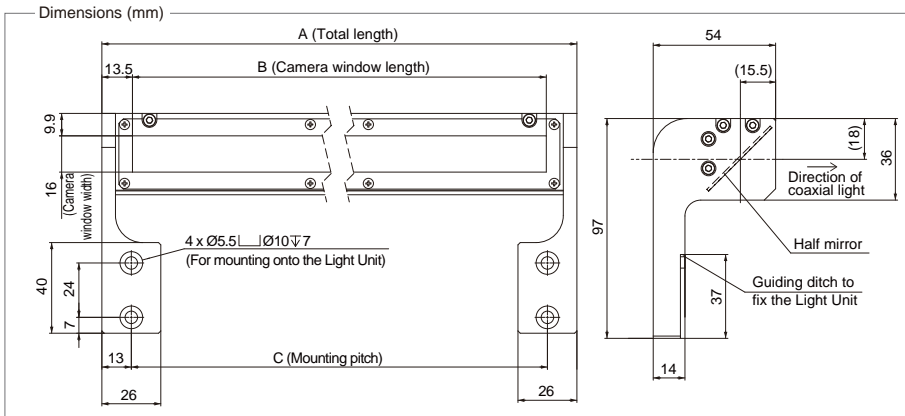
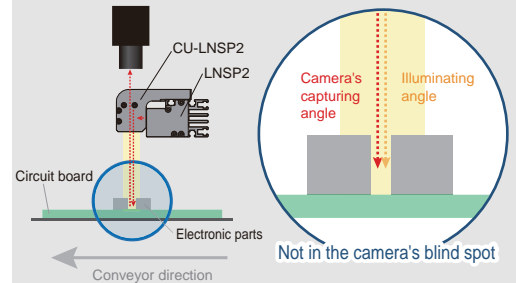

Model name	A	B	C	Weight (max.)	Applicable Light Unit
CU-LNSP2-100-GL	112	85	86	250 g	LNSP2-100SW(-NDF)
CU-LNSP2-200-GL	212	185	186	350 g	LNSP2-200SW(-NDF)
CU-LNSP2-300-GL	312	285	286	450 g	LNSP2-300SW(-NDF)
CU-LNSP2-400-GL	412	385	386	550 g	LNSP2-400SW(-NDF)
CU-LNSP2-500-GL	512	485	486	650 g	LNSP2-500SW(-NDF)

"CCS", "LIGHTING SOLUTION", and "LNSP" are registered trademarks or trademarks of CCS Inc.

CAUTION

- To ensure proper and safe use of the product, please read the Instruction Guide completely before using the product.
- The design and specifications of this product are subject to change without notification for product improvement.
- The workpiece imaging examples included in this pamphlet are intended to serve only as references to help you select a suitable Light Unit. Please verify the functionality and conditions required for your particular application before you make a final selection. The sample workpieces used in this pamphlet have been processed specifically for sample imaging. They are not intended to represent product quality and performance.



CCS Inc.

Headquarters

Shimodachiuri-agaru, karasuma-dori, kamigyo-ku,
Kyoto 602-8011 JAPAN
TEL : +81-75-415-8284 / FAX : +81-75-415-8278
URL : <http://www.ccs-grp.com/>
E-mail : sales@ccs-inc.co.jp

CCS Asia PTE LTD

63 Hillview Avenue #07-10, Lam Soon Industrial
Building, Singapore 669569
TEL : +65-6769-1669 / FAX : +65-6769-3422
URL : <http://www.ccs-asia.com.sg/>
Email : sales@ccs-asia.com.sg

CCS America, Inc

5 Burlington Woods Suite 204, Burlington, MA 01803 USA
TEL : +1-781-272-6900 / FAX : +1-781-272-6902
URL : <http://www.ccsamerica.com/>
Email : info@ccsamerica.com

CCS Inc. Shanghai Office

Room 308B-309, CIMIC Tower No.1090 Century Avenue,
Pu Dong New Area, Shanghai 200120, P.R. China
TEL : +86-21-5835-8728 / FAX : +86-21-5835-8928
Email : ccschina@ccs-inc.co.jp

CCS Europe NV/SA

Bergensesteenweg 421B,
1600 Sint-Pieters-Leeuw, Belgium
TEL : +32-(0)2-333-0080 / FAX : +32-(0)2-333-0081
Email : info@ccseu.com

CCS Inc. Shenzhen office

17B, China Economic Trade Building, 7Rd Zizhu, Zhuzilin,
Futian District, Shenzhen 518040 P.R.China
TEL : +86-755-8279-0477 / FAX : +86-755-8279-0478
Email : ccschina@ccs-inc.co.jp